



E220-400T30D User Manual

433/470MHz 30dBm LoRa Wireless Module



目录

1. Overview.....	3
1.1 Introduction.....	4
1.2 Features.....	4
1.3 Application.....	4
2. Specification and Parameter.....	5
2.1 Limit Parameter.....	5
2.2 Operating Parameter.....	5
3. Size and Pin Definition.....	6
4. Recommended Connection Diagram.....	7
5. Function Description.....	8
5.1 Fixed Transmission.....	8
5.2 Broadcasting Transmission.....	8
5.3 Broadcasting Address.....	9
5.4 Monitor Address.....	9
5.5 Reset.....	9
5.6 AUX Description.....	9
6. Operating Mode.....	11
6.1 Mode Switching.....	11
6.2 Normal mode (Mode 0)	12
6.3 WOR sending mode (Mode 1).....	12
6.4 WOR receiving mode (Mode 2).....	12
6.5 Deep Sleep (Configuration) Mode (Mode 3).....	13
7 Register Read and Write Control.....	13
7.1 Command Format.....	13
7.2 Register Description.....	14
7.3 Factory Default Parameter.....	16
8. Configuration Instruction on Computer.....	17
9. Hardware Design.....	18
10. FAQ.....	19
10.1 Communication range is too short.....	19
10.2 Module is easy to damage.....	19
10.3 BER (Bit Error Rate) is high.....	19
11. Soldering Operation Guidance.....	20
11.1 Reflow Soldering Temperature.....	20
11.2 Reflow Soldering Curve.....	20
12. Related Models.....	21
13. Antenna Recommendation.....	21
13.1 Antenna Recommendation.....	21
14. Package for Bulk Order.....	22
Revision History.....	22
About us.....	22

Disclaimer and copyright notice

The information in this article, including the URL for reference, is subject to change without notice. The document is provided "as is" without warranty of any kind, including any warranty of merchantability, fitness for a particular purpose or non-infringement, and any warranty of any proposal, specification or sample referred to elsewhere. This document does not bear any liability, including any infringement of any patent rights resulting from the use of the information contained in this document. No estoppel or other license, express or implied, is granted herein for the use of intellectual property.

All the test data obtained in this paper are obtained by E-Baite laboratory, and the actual results may be slightly different.

It is hereby declared that all trade names, trade marks and registered trade marks mentioned herein are the property of their respective owners.

The right of final interpretation belongs to Chengdu Yibaite Electronic Technology Co., LTD.

The attention

The contents of this manual may change due to product version upgrade or other reasons. E-baite Electronic Technology Co., Ltd. reserves the right to modify the contents of this manual without any notice or prompt. This manual is only used as a guide, and Chengdu Yibaite Electronic Technology Co., Ltd. makes every effort to provide accurate information in this manual, but Chengdu Yibaite Electronic Technology Co., Ltd. does not guarantee that the content of this manual is completely free of errors, and all statements, information and Suggestions in this manual do not constitute any express or implied warranty.

1. Overview

1.1 Introduction

E220-400T30D adopts a new generation of LoRa spread spectrum technology and a wireless serial port module (UART) designed based on the LLCC68 chip scheme. It has a variety of transmission methods, works in the (410.125 ~ 493.125MHz) frequency band (default 433.125MHz), TTL level output, compatible with 3.3V and 5V IO port voltage.

E220-400T30D adopts a new generation of LoRa spread spectrum technology, supports air wake-up, carrier sense, communication key and other functions, supports sub-package length setting, and Ebyte provides customized development services.

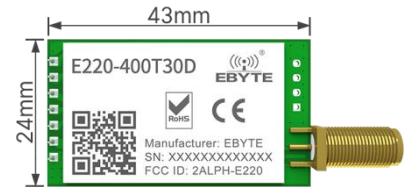

1.2 Features

- The new LoRa spread spectrum modulation technology developed based on LLCC68, it brings a longer communication distance and stronger anti-interference ability;
- Support users to set the communication key by themselves, and it cannot be read, which greatly improves the confidentiality of user data;
- Support LBT function, monitor the channel environment noise before sending, which greatly improves the communication success rate of the module in harsh environments;
- Support RSSI signal strength indicator function for evaluating signal quality, improving communication network, and ranging;
- Support air wakeup, that is ultra-low power consumption, suitable for battery-powered applications;
- Support point to point transmission, broadcast transmission, channel sense;
- Support deep sleep, the power consumption of the whole machine is about 5uA in this mode;
- The module has built-in PA+LNA, and the communication distance can reach 5km under ideal conditions;
- The parameters are saved after power-off, and the module will work according to the set parameters after power-on;
- Efficient watchdog design, once an exception occurs, the module will automatically restart and continue to work according to the previous parameter settings;
- Support the bit rate of 2.4k~62.5kbps;
- Support 3.0~5.5V power supply, power supply greater than 5V can guarantee the best performance;
- Industrial standard design, supporting long-term use at -40~+85°C;
- SMA antenna interface.

1.3 Application

- Home security alarm and remote keyless entry;
- Smart home and industrial sensors;
- Wireless alarm security system;
- Building automation solutions;
- Wireless industrial-grade remote control;
- Advanced Meter Reading Architecture (AMI);
- Automotive industry applications.

2. Specification and Parameter

2.1 Limit Parameter

Table 2-1 Limit parameter table

Main Parameter	Performance		Remark
	Min.	Min.	
Power Supply (V)	0	5.5	Exceeding the maximum value may burn the module permanently
Blocking Power (dBm)	-	10	-
Operating Temperature (°C)	-40	+85	Industrial grade

2.2 Operating Parameter

Table 2-2 Working parameter table

Main Parameter	Performance			Remark
	Min.	Typ.	Max.	
Operating voltage (V)	3.0	5	5.5	≥5.0 V ensures output power
Communication level (V)	-	3.3	-	For 5V TTL, it may be burning down
Operating temperature (°C)	-40	-	+85	Industrial design
Operating frequency (MHz)	410.125	-	493.125	Support ISM band
Power consumption	TX current(mA)	-	620	Instant power consumption @30dBm
	RX current (mA)	-	17.2	5V Voltage
	Sleep current (μA)	-	5	Sleep mode
Max Tx power (dBm)	29	30	30	-
Receiving sensitivity (dBm)	-146	-147	-148	Air data rate 2.4kbps
Air data rate (bps)	2.4k	2.4k	62.5k	To control via user's program
Distance for reference	10km			Test condition : clear and open area, antenna gain: 5dBi, antenna height: 2.5m, air data rate: 2.4kbps
TX length	200 Byte			Can be configured via command as 32/64/128/200 bytes per packet to transmit
Buffer	400 Byte			-
Modulation	LoRa			New generation LoRa modulation technology
Communication interface	UART Serial Port			TTL Level
Package	Package			-
Size	24*43mm			-
Antenna	SMA-K			50 ohm impedance

3. Size and Pin Definition

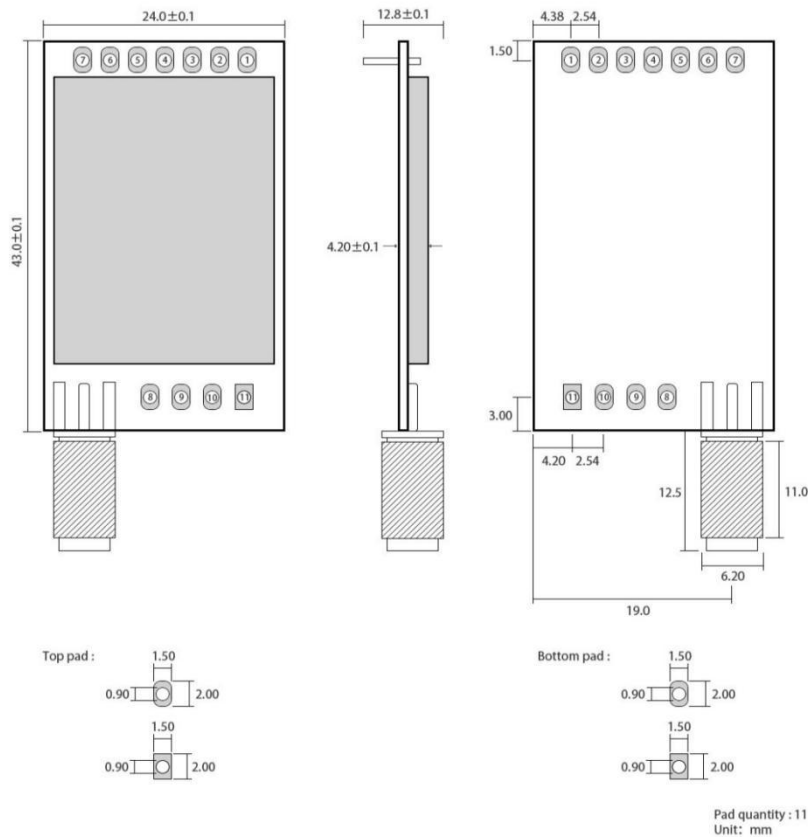

Figure 3-1 Mechanical size and pin definition

Table 3-1 Pin definition table

No.	Name	Direction	Function
1	M0	Input (weak pull-up)	Work with M1 to decide 4 working modes of module (not float, if not used, could be grounded).
2	M1	Input (weak pull-up)	Work with M0 to decide 4 working modes of module (not float, if not used, could be grounded).
3	RXD	Input	TTL UART inputs, connects to external TXD output pin.
4	TXD	Output	TTL UART outputs, connects to external RXD input pin.
5	AUX	Output	Used to indicate the working status of the module; wakes up the external MCU, and outputs low level during power-on self-check initialization; (can be left floating)
6	VCC	Input	Voltage range: 3.0~5.5V DC
7	GND	Input	Ground
8	Fixed hole	-	Fixed hole
9	Fixed hole	-	Fixed hole
10	Fixed hole	-	Fixed hole
11	Fixed hole	-	Fixed hole

4. Recommended Connection Diagram

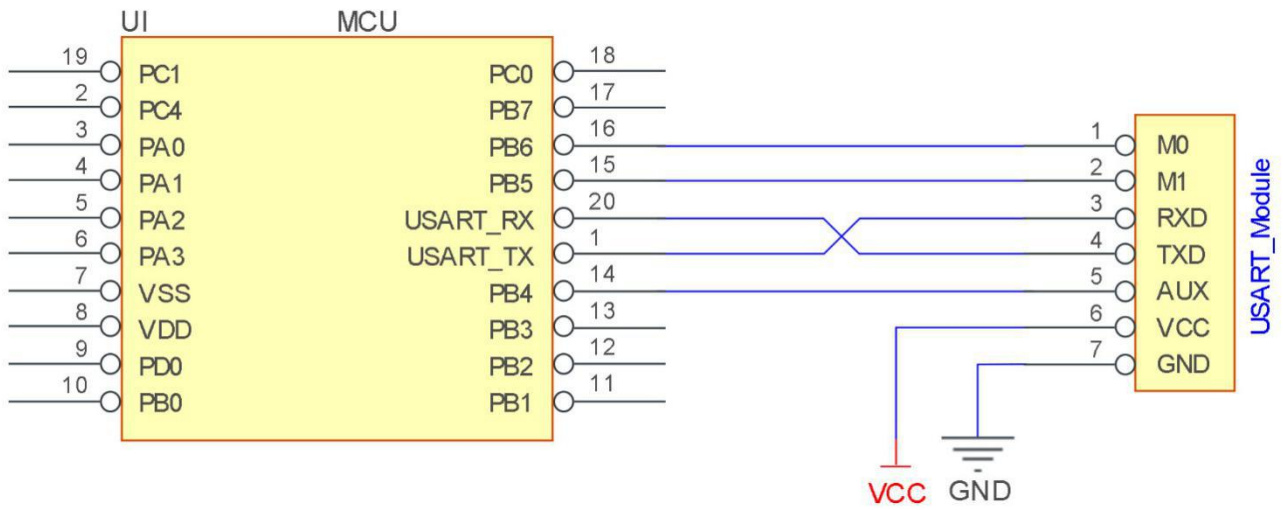

Figure 4-1 Recommended connection diagram

Table 4-1 Description

No.	Brief description of the connection between the module and the MCU (the above figure uses the STM8L MCU as an example)
1	The wireless serial port module is TTL level, please connect with TTL level MCU.
2	For some 5V MCU, it may be necessary to add 4-10K pull-up resistors to the TXD and AUX pins of the module.

5. Function Description

5.1 Fixed Transmission

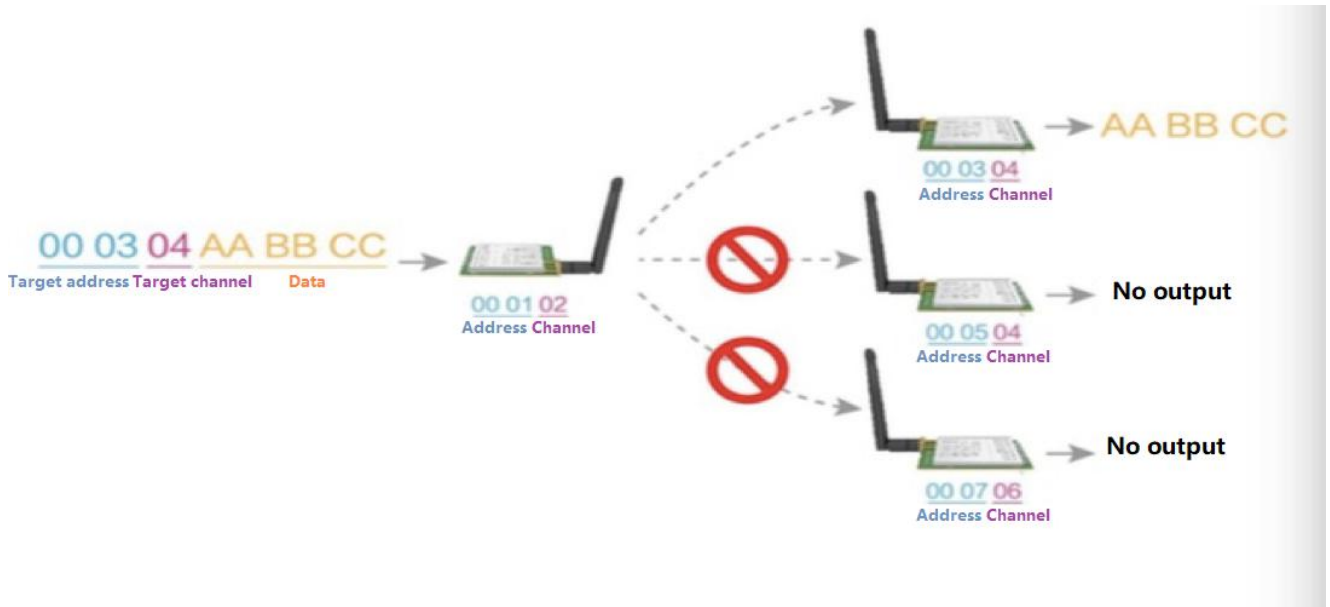

Figure 5-1 Fixed Transmission

5.2 Broadcasting Transmission

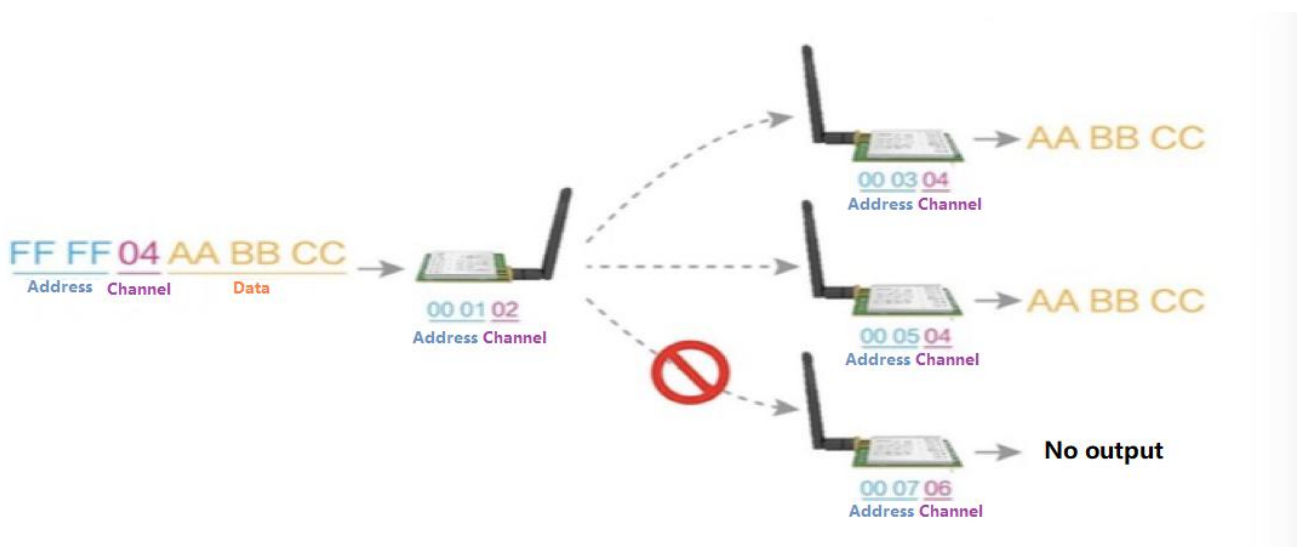

Figure 5-2 Broadcasting Transmission

5.3 Broadcasting Address

- Example: Set the address of module A to 0xFFFF and the channel to 0x04.
- When module A is used as a transmitter (same mode, transparent transmission mode), all receiving modules under the 0x04 channel can receive data to achieve the purpose of broadcasting.

5.4 Monitor Address

- For example: Set the address of module A as 0xFFFF or 0x0000, and the channel as 0x04;
- When module A is the receiver, it can receive the data sent from all modules under channel 0x04, the purpose of monitor is realized.

5.5 Reset

- After the module is powered on, AUX will immediately output low level, perform hardware self-check, and set the working mode according to user parameters; During this process, AUX keeps low level, and AUX outputs high level after completion, and starts to work normally according to the working mode formed by M1 and M0; Therefore, the user needs to wait for the rising edge of AUX as the starting point for the module to work normally.

5.6 AUX Description

- AUX Pin can be used as indication for wireless send & receive buffer and self-check.
- It can indicate whether there are data that are not sent yet via wireless way, or whether all wireless data has been sent through UART, or whether the module is still in the process of self-check initialization.

5.6.1 Indication of UART Output

- To wake up external MCU

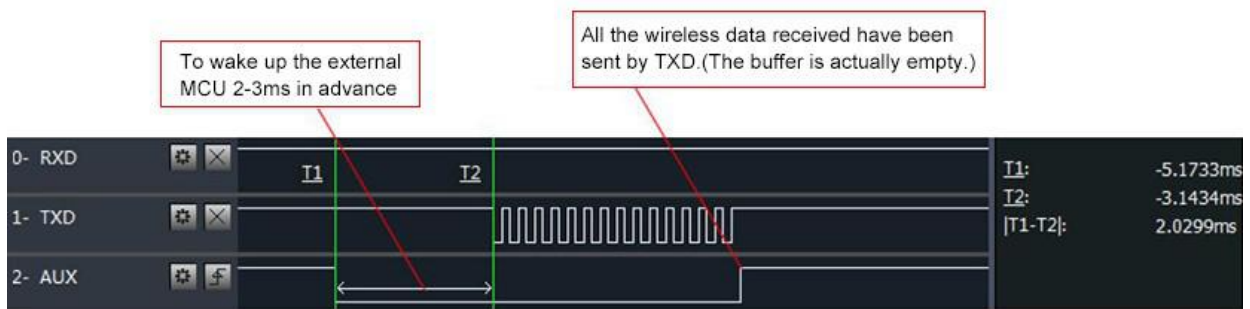

Timing Sequence Diagram of AUX when TXD pin transmits

Figure 5-3 To wake up external MCU

5.6.2 Indication of Wireless Transmitting

- Buffer empty: the data in the internal 400-byte buffer is written to the wireless chip (automatic sub-packaging);
When AUX=1, the user continuously initiates data less than 400 bytes without overflow;
When AUX=0, the buffer is not empty: the data in the internal 400-byte buffer has not been written to the wireless chip and the transmission is turned on. At this time, the module may be waiting for the end of the user data to time out, or the wireless sub-packet transmission is in progress;
[Note]: When AUX=1, it does not mean that all serial port data of the module has been transmitted wirelessly, and the last packet of data may be being transmitted.

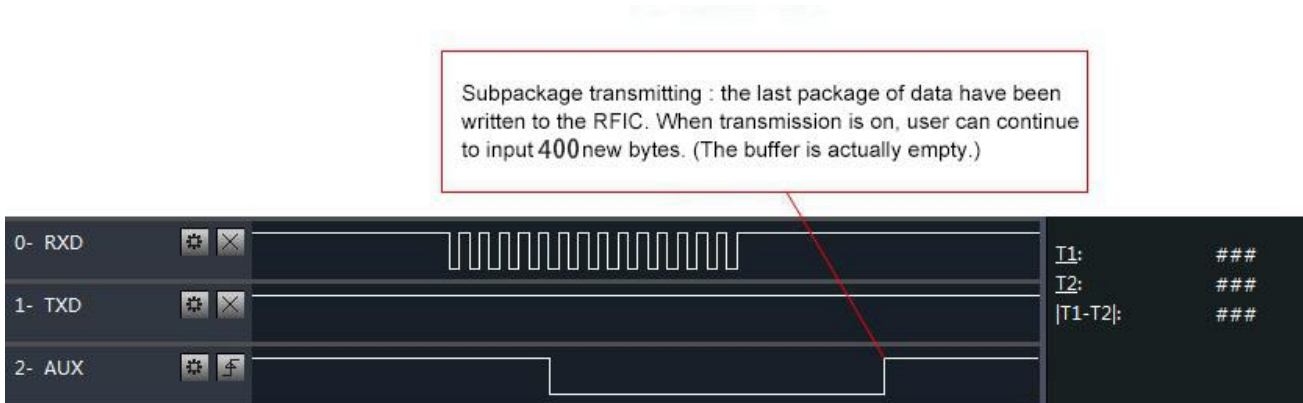

Timing Sequence Diagram of AUX when RXD pin receives

Figure 5-4 Transmitting indication

5.6.3 Configuration Procedure of Module

- Only happened when power-on resetting or exiting sleep mode

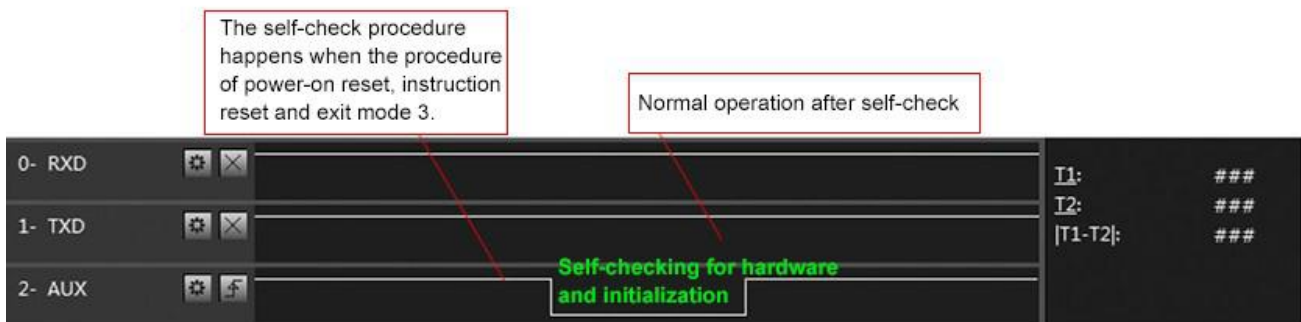

Timing Sequence Diagram of AUX when self-check

Figure 5-5 Configuration mode

5.6.4 Notes for AUX

Table 5-1 Notes for AUX

No.	Description
1	For function 1 & function 2 mentioned above, the priority should be given to the one with low level output, which means if it meets each of any low level output condition, AUX outputs low level, if none of the low level condition is met, AUX outputs high level.
2	When AUX outputs low level, it means the module is busy & cannot conduct operating mode checking. Within 1ms since AUX outputs high level, the mode switch will be completed.
3	After switching to new operating mode, it will not work in the new mode immediately until AUX rising edge lasts for 2ms. If AUX stays on the high level, the operating mode switch can be affected immediately.
4	When the user switches to other operating modes from mode 3 (sleep mode) or it's still in reset process, the module will reset user parameters, during which AUX outputs low level.
5	Due to the characteristics of the LoRa modulation method, the information transmission delay is much longer than FSK. It is recommended that customers do not transmit large amounts of data at low airspeeds to avoid communication abnormalities caused by data accumulation and data loss.

6. Operating Mode

There are four operating modes, which are set by M1 and M0, the details are as follows:

Mode (0-3)	M1	M0	Description	Remark
0 Transmission Mode	0	0	UART and wireless channel are open, transparent transmission is on	
1 WOR Transmitting Mode	0	1	WOR Transmitter	
2 WOR Receiving Mode	1	0	WOR Receiver	Supports wake up over air
3 Deep Sleep Mode	1	1	Module goes to sleep (automatically wake up when configuring parameters)	Supports configuration

6.1 Mode Switching

Table 6-1 Mode Switching

No.	Remark
1	<ul style="list-style-type: none"> Users can combine M1 and M0 with high and low levels to determine the operating mode. Two GPIOs of the MCU can be used to control mode switching; After changing M1 and M0: If the module is idle, after 1ms, it can start working according to the new mode; If the serial port data of the module has not been transmitted through the wireless, the new working mode can be switched after the transmission is completed; If the module receives the wireless data and transmits the data through the serial port, it needs to finish transmission before switching the new working mode; Therefore, mode switching can only be valid when AUX output is 1, otherwise it will delay switching
2	<ul style="list-style-type: none"> For example, users continuously inputs a large amount of data and simultaneously performs mode switching. At this time, the switching mode operation is invalid; the module will process all the user data before performing the new mode detection; Therefore, the general recommendation is to detect the output state of the AUX pin and switch after 2ms when the output is high.

3	<ul style="list-style-type: none"> ● When the module is switched from other modes to sleep mode, if the data has not been processed yet; ● The module will process these data (including receiving and sending) before entering sleep mode. This feature can be used for fast sleep, which saves power; for example, the transmitter module works in mode 0, the user transmits the serial port data "12345", and then does not have to wait for the AUX pin to be idle (high level), and can directly switch to sleep mode. And the user's main MCU immediately sleeps, the module will automatically transmit the user data through the wireless, and automatically enters sleep within 1ms; ● This saves MCU's working time and reduces power consumption.
4	<ul style="list-style-type: none"> ● Similarly, any mode switching can use this feature. After the module processes the current mode event, it will automatically enter the new mode within 1ms; thus, eliminating the need for the user to query AUX and achieve the purpose of fast switching; ● For example, switching from the transmit mode to the receive mode; the user MCU can also enter sleep before the mode switch, and use the external interrupt function to acquire the AUX change, thereby performing mode switching.
5	<ul style="list-style-type: none"> ● This operation mode is very flexible and efficient, and is designed according to the user's MCU's operation convenience, and can reduce the workload of the entire system as much as possible, improve system efficiency, and reduce power consumption.

6.2 Normal mode (Mode 0)

Table 6-2 Normal mode

Type	When M0 = 0, M1 = 0, the module works in mode 0
Transmitting	Users can input data through the serial port and the module will start wireless transmission.
Receiving	The module wireless receiving function is turned on, and after receiving the wireless data, it will be output through the serial port TXD pin.

6.3 WOR sending mode (Mode 1)

Table 6-3 WOR sending mode

Type	When M0 = 1, M1 = 1, the module works in mode 1
Transmitting	When defined as a transmitting party, a preamble is automatically added before transmitting.
Receiving	It can receive data normally, the receiving function is the same as mode 0.

6.4 WOR receiving mode (Mode 2)

Table 6-4 WOR receiving mode

Type	When M0 = 0, M1 = 1, the module works in mode 2
------	---

Transmitting	Wireless transmission off
Receiving	Can only receive data in WOR transmission mode (mode 1)

6.5 Deep Sleep (Configuration) Mode (Mode 3)

Table 6-5 Sleep mode

Type	When M0 = 1, M1 = 1, the module works in mode 3
Transmitting	Unable to transmit wireless data
Receiving	Unable to receive wireless data
Note	When from the sleep mode to other modes, the module will reconfigure the parameters. During the configuration process, AUX will remain low; After configuration, it outputs high level, we suggest that user test rising edge T_BUSY.

7 Register Read and Write Control

7.1 Command Format

In configuration mode (mode 3: M1=1, M0=1), the supported command list is as follows (when setting, only 9600, 8N1 format is supported):

Table 7-1 Command format

No	Command Format	Description												
1	Write Register	Command: C0+starting address+length+parameters Response: C1+starting address+length+parameters Example 1: Channel is 0x09 <table border="0" style="margin-left: 40px;"> <tr> <td>command</td> <td>starting address</td> <td>length</td> <td>parameter</td> </tr> <tr> <td>Send: C0</td> <td>04</td> <td>01</td> <td>09</td> </tr> <tr> <td>Return: C1</td> <td>04</td> <td>01</td> <td>09</td> </tr> </table> Example 2: Configure module address (0x1234), serial port (9600 8N1), air speed (2.4K) Send: C0 00 03 12 34 62 Return: C1 00 03 12 34 62	command	starting address	length	parameter	Send: C0	04	01	09	Return: C1	04	01	09
command	starting address	length	parameter											
Send: C0	04	01	09											
Return: C1	04	01	09											
2	Read Register	Command: C1+starting address+parameters Response: C1+starting address+length+parameters Example : Read channel <table border="0" style="margin-left: 40px;"> <tr> <td>command</td> <td>starting address</td> <td>length</td> <td>parameter</td> </tr> <tr> <td>Send: C1</td> <td>04</td> <td>01</td> <td></td> </tr> <tr> <td>Return: C1</td> <td>04</td> <td>01</td> <td>09</td> </tr> </table>	command	starting address	length	parameter	Send: C1	04	01		Return: C1	04	01	09
command	starting address	length	parameter											
Send: C1	04	01												
Return: C1	04	01	09											

		Example 2: Read module address, serial port, and airspeed at the same time Send: C1 00 03 Return: C1 00 03 12 34 62												
3	Write Temporary Register	Command: C2+starting address+parameters Response: C1+starting address+length+parameters Example 1: Channel is 0x09 <table style="margin-left: 20px;"> <tr> <td>command</td> <td>starting address</td> <td>length</td> <td>parameter</td> </tr> <tr> <td>Send: C2</td> <td>04</td> <td>01</td> <td>09</td> </tr> <tr> <td>Return: C1</td> <td>04</td> <td>01</td> <td>09</td> </tr> </table> Example 2: Configure module address (0x1234), network address (0x00), serial port (9600 8N1) and air data rate (2.4K) Send: C2 00 03 12 34 62 Return: C1 00 03 12 34 62	command	starting address	length	parameter	Send: C2	04	01	09	Return: C1	04	01	09
command	starting address	length	parameter											
Send: C2	04	01	09											
Return: C1	04	01	09											
4	Wrong Format	Wrong format respond: FF FF FF												

7.2 Register Description

Address	Read or Write	Name	Description	Remark			
00H	Read/Write	ADDH	ADDH (default 0)	High byte and low byte of module address; Note: When the module address is equal to FFFF, it can be used as the broadcast and monitor address, that is: the module will not perform address filtering at this time			
01H	Read/Write	ADDL	ADDL (default 0)				
02H	Read/Write	REG0	7	6	5	UART Serial Port Rate (bps)	For the two modules that communicate with each other, the serial port baud rate can be different, and the verification method can also be different; When continuously transmitting large data packets, users need to consider the data congestion caused by the same baud rate, and may even be lost; It is generally recommended that the baud rate of the two communication parties be the same.
			0	0	0	UART Rate is 1200	
			0	0	1	UART Rate is 2400	
			0	1	0	UART Rate is 4800	
			0	1	1	UART Rate is 9600 (default)	
			1	0	0	UART Rate is 19200	
			1	0	1	UART Rate is 38400	
			1	1	0	UART Rate is 57600	
			1	1	1	UART Rate is 115200	
			4	3	Serial Parity Bit		The serial port mode of the communication parties can be different;
			0	0	8N1 (default)		
			0	1	8O1		
			1	0	8E1		
			1	1	8N1 (equal to 00)		
2	1	0	Air Data Rate (bps)	The air rate of both parties must be the same; The higher the air rate, the smaller the delay and the shorter the transmission distance.			
0	0	0	Air Data Rate 2.4k				

			0	0	1	Air Data Rate 2.4k				
			0	1	0	Air Data Rate 2.4k (default)				
			0	1	1	Air Data Rate 4.8k				
			1	0	0	Air Data Rate 9.6k				
			1	0	1	Air Data Rate 19.2k				
			1	1	0	Air Data Rate 38.4k				
			1	1	1	Air Data Rate 62.5k				
03H	Read/ Write	REG1	7	6	Sub-Packet Setting		The data sent by the user is less than the sub-packet length, and the serial port output of the receiving end appears as an uninterrupted continuous output;			
			0	0	200 bytes (default)					
			0	1	128 bytes					
			1	0	64 bytes					
			1	1	32 bytes					
			5	RSSI Ambient noise enable		After enabling, you can send commands C0 C1 C2 C3 in transmission mode or WOR sending mode to read registers; Register 0x00: Current environmental noise RSSI; Register 0X01: RSSI when receiving data last time (The current channel noise is: dBm = - (256 - RSSI)); Instruction format: C0 C1 C2 C3+start address+read length; Return: C1 + address + read length + read valid value; for example: send C0 C1 C2 C3 00 01 Return C1 00 01 RSSI (address can only start from 00)				
			0	Disable (Default)						
			1	Enable		The relationship between power and current is non-linear, and the power supply has the highest efficiency at maximum power; The current will not decrease in the same proportion as the power decreases.				
			4	3	2		Reserve			
			1	0	Transmitting Power					
			0	0	30dBm (default)					
						0	1	27dBm		
						1	0	24dBm		
			1	1	21dBm					
04H	Read/ Write	REG2	Channel Control (CH) 0-83 represents a total of 84 channels				Actual frequency = 410.125 + CH *1M			
05H	Read/ Write	REG3	7	Enable RSSI Byte		After being enabled, the module receives wireless data and outputs it through the serial port TXD, followed by an RSSI strength byte.				
			0	Disable (Default)						
			1	Enable						
			6	Transmission Method		During fixed transmission, the module will recognize the first three bytes of serial data as: address high + address low + channel, and use it as a wireless transmission target.				
			0	Transparent transmission mode (default)						
			1	Fixed transmission mode						
			5	Reserve						
			4	LBT Enable		After enabling, monitoring will be conducted before wireless data transmission, which can avoid interference to a certain extent, but may cause data delay;				
			0	Disable (default)						
1	Enable		The maximum stay time of LBT is 2 seconds, and it will be issued forcibly when it reaches 2 seconds.							

			3	Reserve			
			2	1	0	WOR Cycle	<p>Only valid for mode 1;</p> <p>Cycle T= (1+WOR)*500ms, the maximum is 4000ms, the minimum is 500ms;</p> <p>The longer the WOR monitoring interval period, the lower the average power consumption, but the greater the data delay;</p> <p>Both sender and receiver must agree (very important)</p>
			0	0	0	500ms	
			0	0	1	1000ms	
			0	1	0	1500ms	
			0	1	1	2000ms	
			1	0	0	2500ms	
			1	0	1	3000ms	
			1	1	0	3500ms	
			1	1	1	4000ms	
06H	Write	CRYPT_H	Key high byte (default 0)				
07H	Write	CRYPT_L	Key low byte (default 0)				

Table 7-2 Register description

7.3 Factory Default Parameter

Table 7-3 Default parameters

Model		Factory default parameter: c0 00 00 62 00 17					
Module No.	Frequency	Module No.	Frequency	Module No.	Frequency	Module No.	Frequency
E220-400T30D	433.125MHz	0x0000	0x17	2.4kbps	9600	8N1	30dbm

8. Configuration Instruction on Computer

- The following figure shows the display interface of the E220-400T30D configuration host computer. The user can switch to the command mode through M0 and M1, and quickly configure and read the parameters on the host computer.

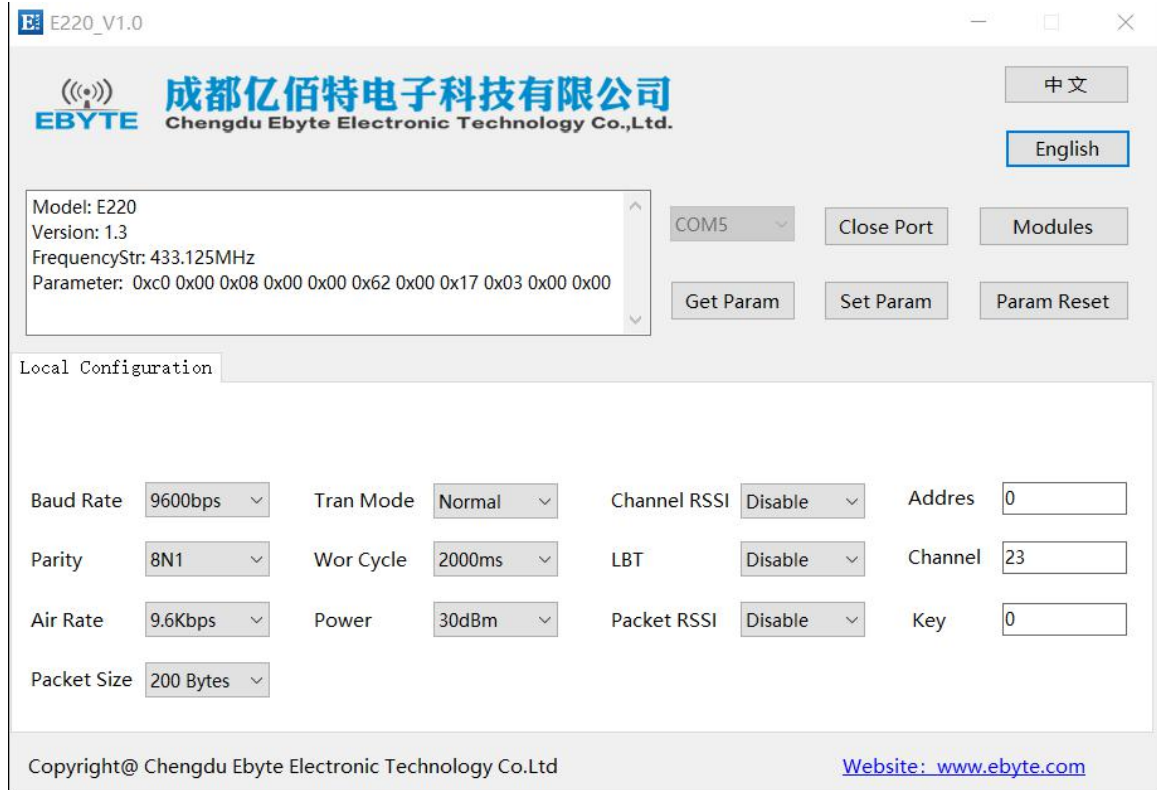

- In the configuration of the host computer, the module address, frequency channel, network ID, and key are all displayed in decimal mode; the value range of each parameter:

Network address: 0~65535

Frequency channel: 0~83

Key: 0~65535

9. Hardware Design

- It is recommended to use a DC stabilized power supply to supply power to the module. The power ripple coefficient should be as small as possible, and the module must be reliably grounded;
- Please pay attention to the correct connection of the positive and negative poles of the power supply. Reverse connection may cause permanent damage to the module;
- Please check the power supply to ensure that it is within the recommended power supply voltage. If it exceeds the maximum value, it will cause permanent damage to the module;
- Please check the stability of the power supply, the voltage should not fluctuate greatly and frequently;
- When designing the power supply circuit for the module, it is often recommended to reserve more than 30% of the margin, and the whole machine is conducive to long-term stable operation;
- The module should be as far away as possible from power supply, transformer, high frequency wiring and other parts with large electromagnetic interference;
- High-frequency digital traces, high-frequency analog traces, and power traces must avoid under the module. If they really need to pass under the module, assuming that the module is soldered to the Top Layer, lay copper on the Top Layer of the contact part of the module (all copper and Good grounding), must be close to the digital part of the module and routed in the Bottom Layer;
- Assuming that the module is soldered or placed on the Top Layer, it is also wrong to randomly route the wires on the Bottom Layer or other layers, which will affect the stray and receiving sensitivity of the module to varying degrees;
- Assuming that there are devices with large electromagnetic interference around the module, it will greatly affect the performance of the module. According to the intensity of the interference, it is recommended to stay away from the module. If the situation permits, proper isolation and shielding can be done;
- Assuming that there are traces with large electromagnetic interference around the module (high-frequency digital, high-frequency analog, power wiring), it will also greatly affect the performance of the module. According to the intensity of the interference, it is recommended to stay away from the module. Isolation and shielding;
- Try to stay away from part of the physical layer that is also 2.4GHz TTL protocol, such as: USB3.0;
- The antenna installation structure has a great influence on the performance of the module. Make sure that the antenna is exposed and it is best to be vertically upward;
- When the module is installed inside the case, a high-quality antenna extension cable can be used to extend the antenna to the outside of the case;
- The antenna must not be installed inside the metal shell, which will greatly reduce the transmission distance.

10. FAQ

10.1 Communication range is too short

- When there is a straight-line communication obstacle, the communication distance will be attenuated accordingly;
- Temperature, humidity, and co-frequency interference will increase the communication packet loss rate;
- The ground absorbs and reflects radio waves, and the test results near the ground are poor;
- Sea water has a strong ability to absorb radio waves, so the seaside test results are poor;
- If there is a metal object near the antenna or placed in a metal shell, the signal attenuation will be very serious;
- The power register setting is wrong, the air speed setting is too high (the higher the air speed, the closer the distance);
- The low voltage of the power supply at room temperature is lower than the recommended value, the lower the voltage, the lower the power output;
- The matching degree of the antenna and the module is poor or the quality of the antenna itself is problematic.

10.2 Module is easy to damage

- Please check the power supply to ensure that it is within the recommended power supply voltage. If it exceeds the maximum value, the module will be permanently damaged;
- Please check the stability of the power supply, and the voltage should not fluctuate greatly and frequently;
- Please ensure anti-static operation during installation and use, and high-frequency components are electrostatically sensitive;
- Please ensure that the humidity during installation and use should not be too high, and some components are humidity sensitive devices;
- If there is no special requirement, it is not recommended to use it at too high or too low temperature.

10.3 BER (Bit Error Rate) is high

- There is co-frequency signal interference nearby, stay away from the interference source or modify the frequency and channel to avoid interference;
- Unsatisfactory power supply may also cause garbled codes. Ensure the reliability of the power supply;
- Poor or too long extension cables and feeders can also cause high bit error rates.

11. Soldering Operation Guidance

11.1 Reflow Soldering Temperature

Table 11-1 Register description

Profile Feature	Sn-Pb Assembly	Pb-Free Assembly
Solder Paste	Sn63/Pb37	Sn96.5/Ag3/Cu0.5
Preheat Temperature min (T _{smin})	100°C	150°C
Preheat temperature max (T _{smax})	150°C	200°C
Preheat Time (T _{smin} to T _{smax})(t _s)	60-120 sec	60-120 sec
Average ramp-up rate(T _{smax} to T _p)	3°C/second max	3°C/second max
Liquidous Temperature (T _L)	183°C	217°C
Time (t _L) Maintained Above (T _L)	60-90 sec	30-90 sec
Peak temperature (T _p)	220-235°C	230-250°C
Average ramp-down rate (T _p to T _{smax})	6°C/second max	6°C/second max
Time 25°C to peak temperature	6 minutes max	8 minutes max

11.2 Reflow Soldering Curve

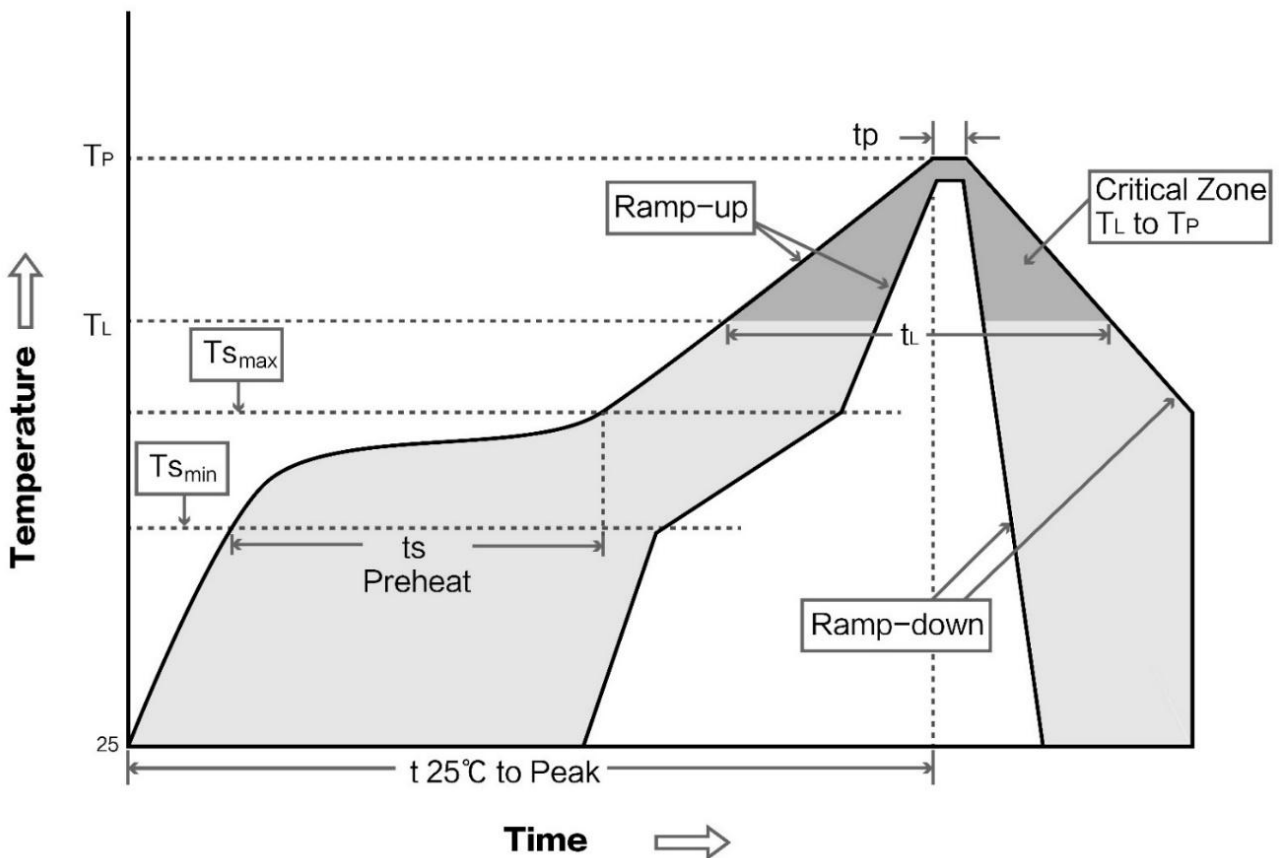

12. Related Models

Model No.	Chip Scheme	Frequency Hz	Tx power dBm	Distance km	Package	Size mm	Interface
E220-400T22S	LLCC68	433/470M	22	5	SMD	16*26	TTL
E220-400T30S	LLCC68	433/470M	30	10	SMD	20*40.5	TTL
E220-900T22S	LLCC68	868/915M	22	5	SMD	16*26	TTL
E220-900T30S	LLCC68	868/915M	30	10	SMD	20*40.5	TTL
E220-400T22D	LLCC68	433/470M	22	5	DIP	21*36	TTL
E220-400T30D	LLCC68	433/470M	30	10	DIP	24*43	TTL
E220-900T22D	LLCC68	868/915M	22	5	DIP	21*36	TTL
E220-900T30D	LLCC68	868/915M	30	10	DIP	24*43	TTL

13. Antenna Recommendation

13.1 Antenna Recommendation

Antennas are an important role in the communication process, and often inferior antennas will have a great impact on the communication system. Therefore, our company recommends some antennas as supporting our company's wireless modules with excellent performance and reasonable prices.

Model No.	Type	Frequency Hz	Interface	Gain dBi	Height mm	Feeder cm	Features
TX433-JZ-5	Rubber Antenna	433M	SMA-J	2.0	52	-	Ultra-short straight, omnidirectional antenna
TX433-JZG-6	Rubber Antenna	433M	SMA-J	2.5	62	-	Sort straight, omnidirectional antenna
TX433-JW-5	Rubber Antenna	433M	SMA-J	2.0	50	-	Ultra-short straight, omnidirectional antenna
TX433-JWG-7	Rubber Antenna	433M	SMA-J	2.5	75	-	Bend rubber, omnidirectional antenna
TX433-JK-11	Rubber Antenna	433M	SMA-J	2.5	110	-	Bendable rubber, omnidirectional antenna
TX433-JK-20	Rubber Antenna	433M	SMA-J	3.0	210	-	Bendable rubber, omnidirectional antenna
TX433-XPL-100	Suction Antenna	433M	SMA-J	3.5	185	100	Small suction antenna, cost-effective
TX433-XP-200	Suction Antenna	433M	SMA-J	4.0	190	200	Middle suction antenna, high

							gain
TX433-XPB-300	Suction Antenna	433M	SMA-J	6.0	965	300	Big suction antenna, high gain
TX490-JZ-5	Rubber Antenna	470/490M	SMA-J	2.0	50	-	Ultra-short straight, omnidirectional antenna
TX490-XPL-100	Suction Antenna	470/490M	SMA-J	3.5	120	100	Small suction antenna, cost-effective

14. Package for Bulk Order

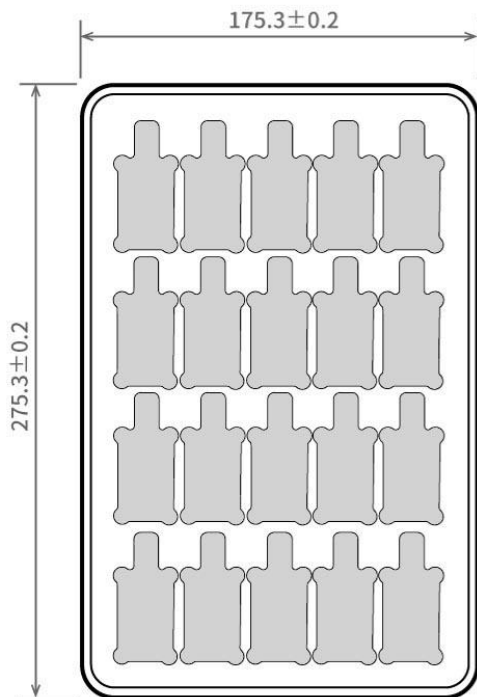

Unit: mm
 Each Layer: 20 pcs
 Each Package: 5 layers

Revision History

Version	Date	Description	Issued by
1.0	2020-8-28	Original version	

About us

Technical support: support@cdebyte.com

Documents and RF Setting download link: www.ebyte.com

Thank you for using Ebyte products! Please contact us with any questions or suggestions: info@cdebyte.com

Official hotline:028-61399028

Web: www.ebyte.com

Address: , Building B5, Mould Industrial Park, 199# Xiqu Ave, High-tech Zone, Chengdu, 611731, Sichuan, China



Chengdu Ebyte Electronic Technology Co.,Ltd.